

CONECTO DOWEL
10NA40-5D-T8 h=90
Przekrój

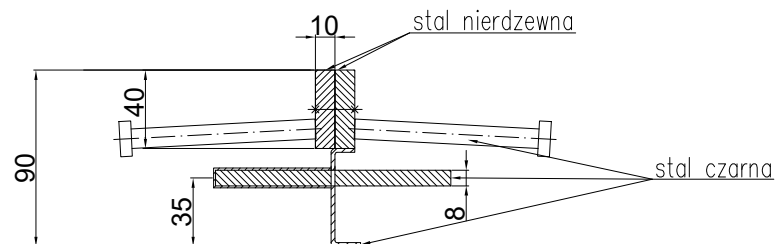

CONECTO DOWEL
10NA40-5D-T8 h=90
Widok

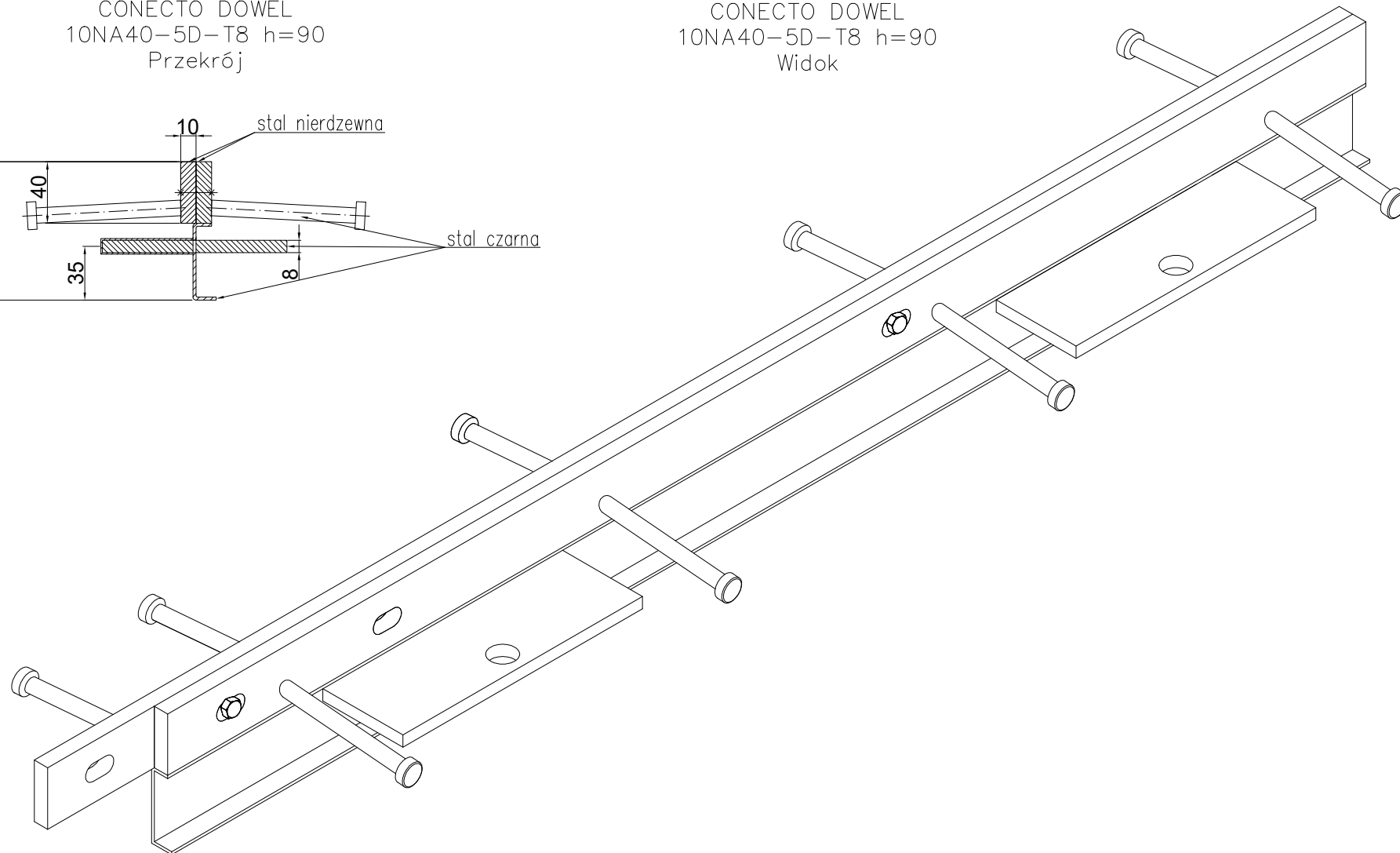

Profil dylatacyjny Conecto Dowel
10NA40-5D-T8 h=90 PL
L=3000, stal nierdzewna

Conecto Profiles Sp. z o.o.
ul. Przemysłowa 39
61-541 Poznań
www.conecto-profiles.com



ROZMIAR / SIZE	SKALA / SCALE	Wszystkie wymiary podano w [mm] All dimensions in [mm]
--	1:1	

PROJEKT	PROJECT	ZŁOŻENIE	SUB ASSEMBLY	RYSunEK	DRAWING	ARKUSZ SHEET	WER REV
--		--			01	1 Z OF 1	