

Conecto Omega
03NB-5D-T8 h=275/290
PRZEKRÓJ
skala 2:1

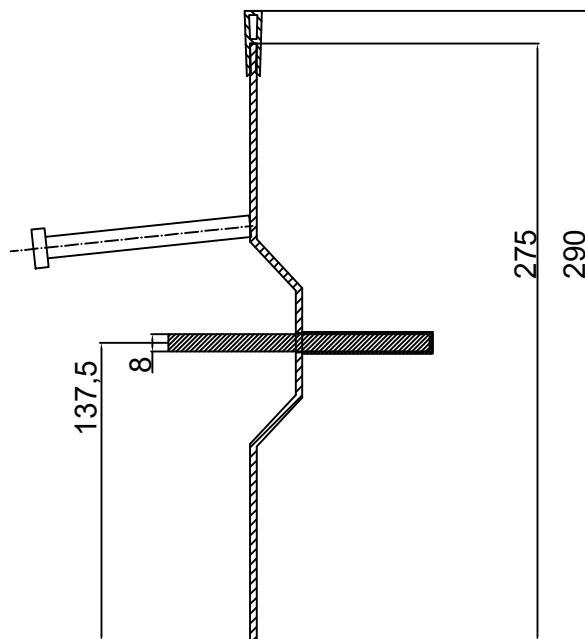

Profil dylatacyjny Omega
03NB-5D-T8 h=275/290

RZUT
skala 1:1,25

Conecto Omega
03NB-5D-T8 h=275/290
Rzut aksonometryczny

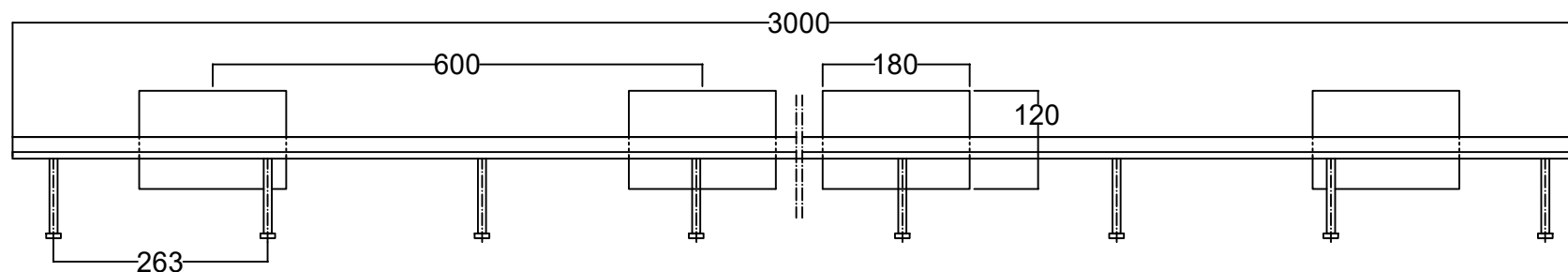
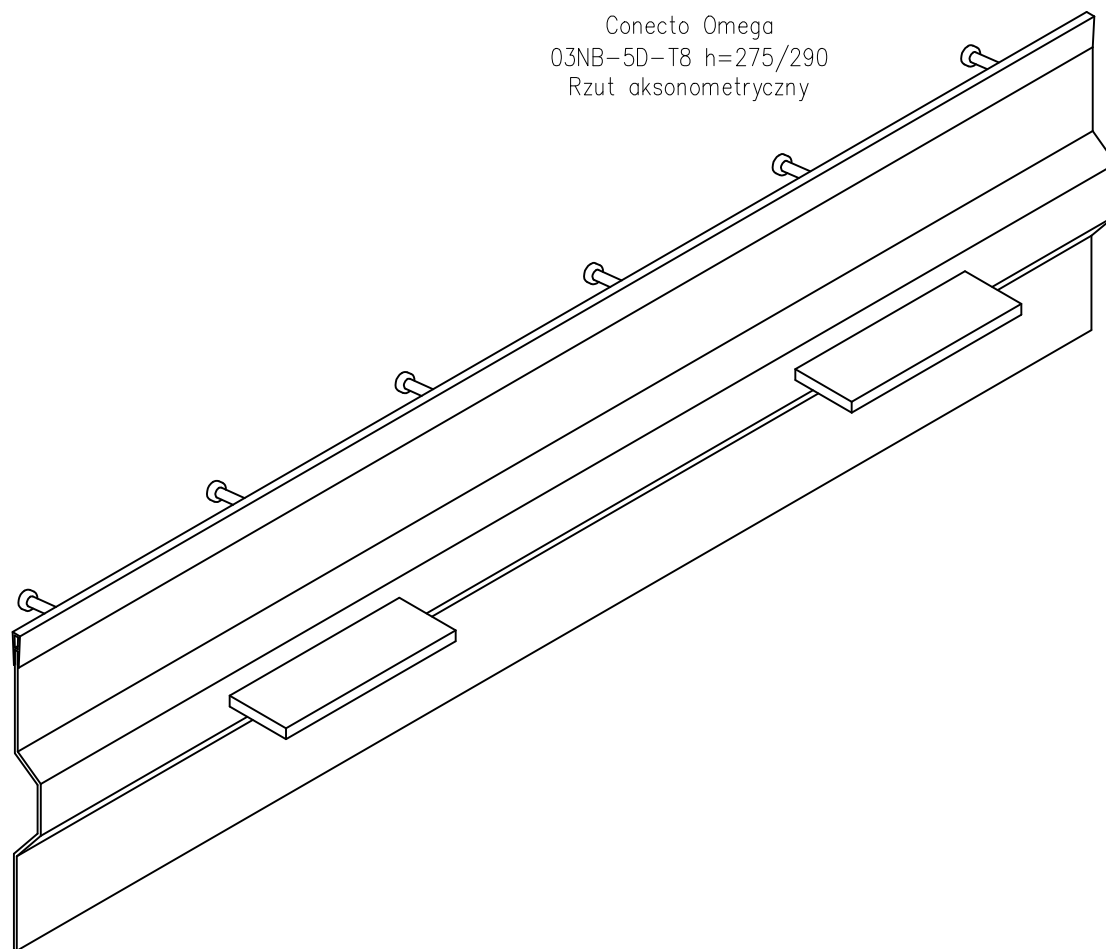

Profil dylatacyjny Conecto Omega
03NB-5D-T8 h=275/290 z nakładką
L=3000, stal czarna

Conecto Profiles Sp. z o.o.
ul. Przemysłowa 39
61-541 Poznań
www.conecto-profiles.com



ROZMIAR / SIZE	SKALA / SCALE	Wszystkie wymiary podano w [mm] All dimensions in [mm]		PROJEKT	PROLECT	ZŁOŻENIE	SUB ASSEMBLY	RYSUNEK	DRAWING	ARKUSZ	VER	REV
A3	1:1			--		--			01	1	Z	1
										DF		