

CONECTO SINUS
04NS50-4D-T8 h=275
Przekrój

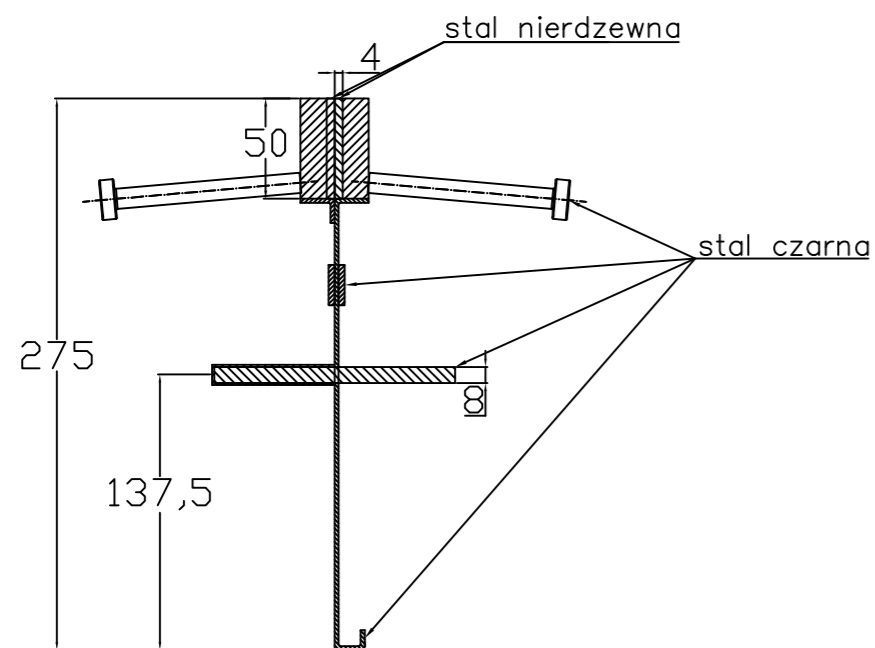

CONECTO SINUS
04NS50-4D-T8 h=275
Rzut aksonometryczny

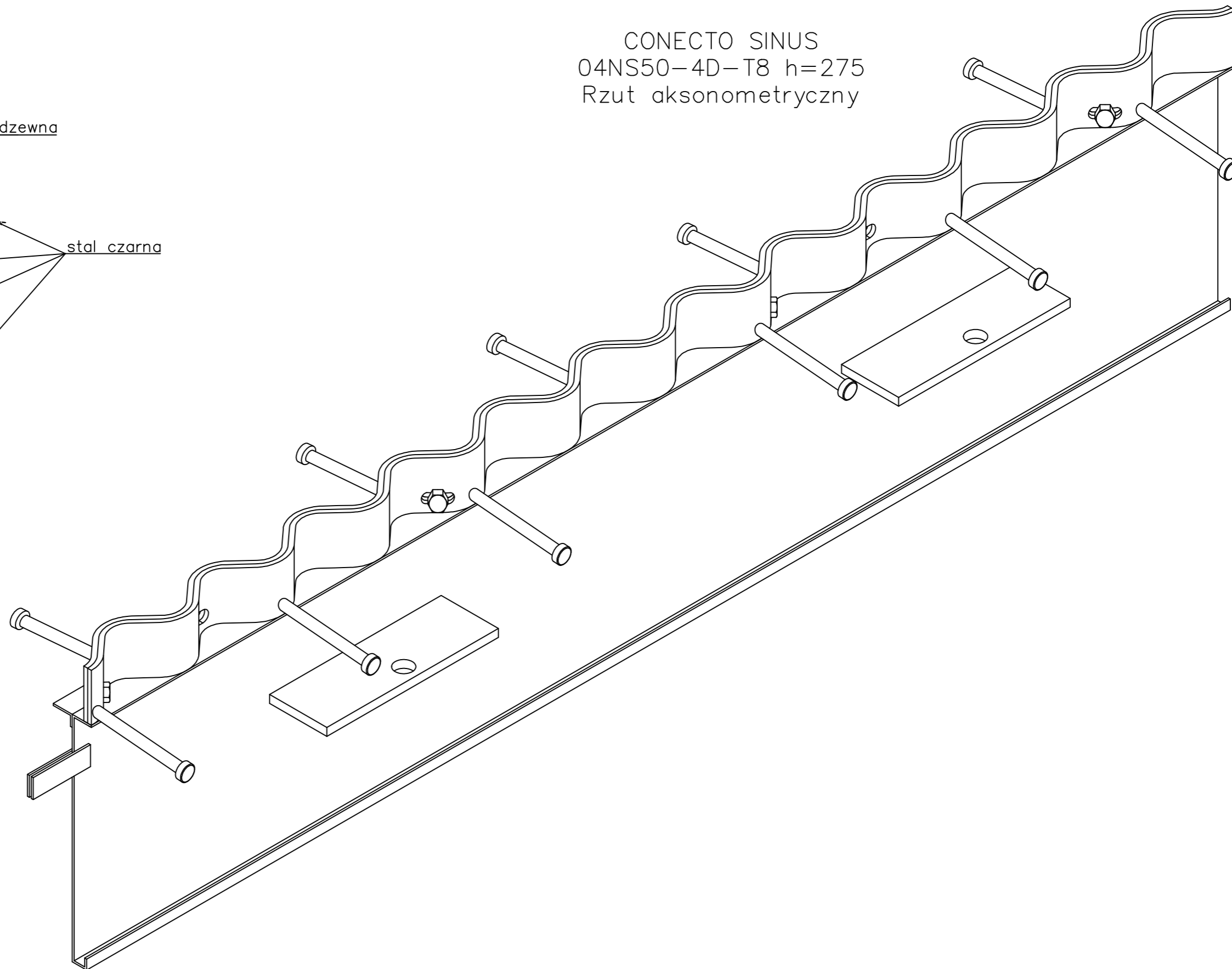

Profil dylatacyjny Conecto Sinus
04NS50-4D-T8 h=275
L=2400, Stal nierdzewna

Conecto Profiles Sp. z o.o.
ul. Przemysłowa 39
61-541 Poznań
www.conecto-profiles.com



ROZMIAR / SIZE A3	SKALA / SCALE 1:1	Wszystkie wymiary podano w [mm] All dimensions in [mm]
----------------------	----------------------	---

PROJEKT	PROJECT	ZŁOŻENIE	SUB ASSEMBLY	RYSUNEK	DRAWING	ARKUSZ SHEET	WER REV
--	--	--	--	01	01	1 Z OF 1	