

CONECTO SINUS
06NC115-5D-T8 h=155
Przekrój

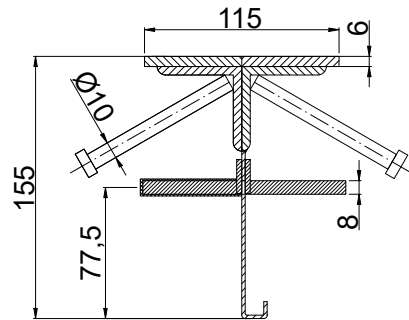

CONECTO SINUS
06NC115-5D-T8 h=155
Rzut aksonometryczny

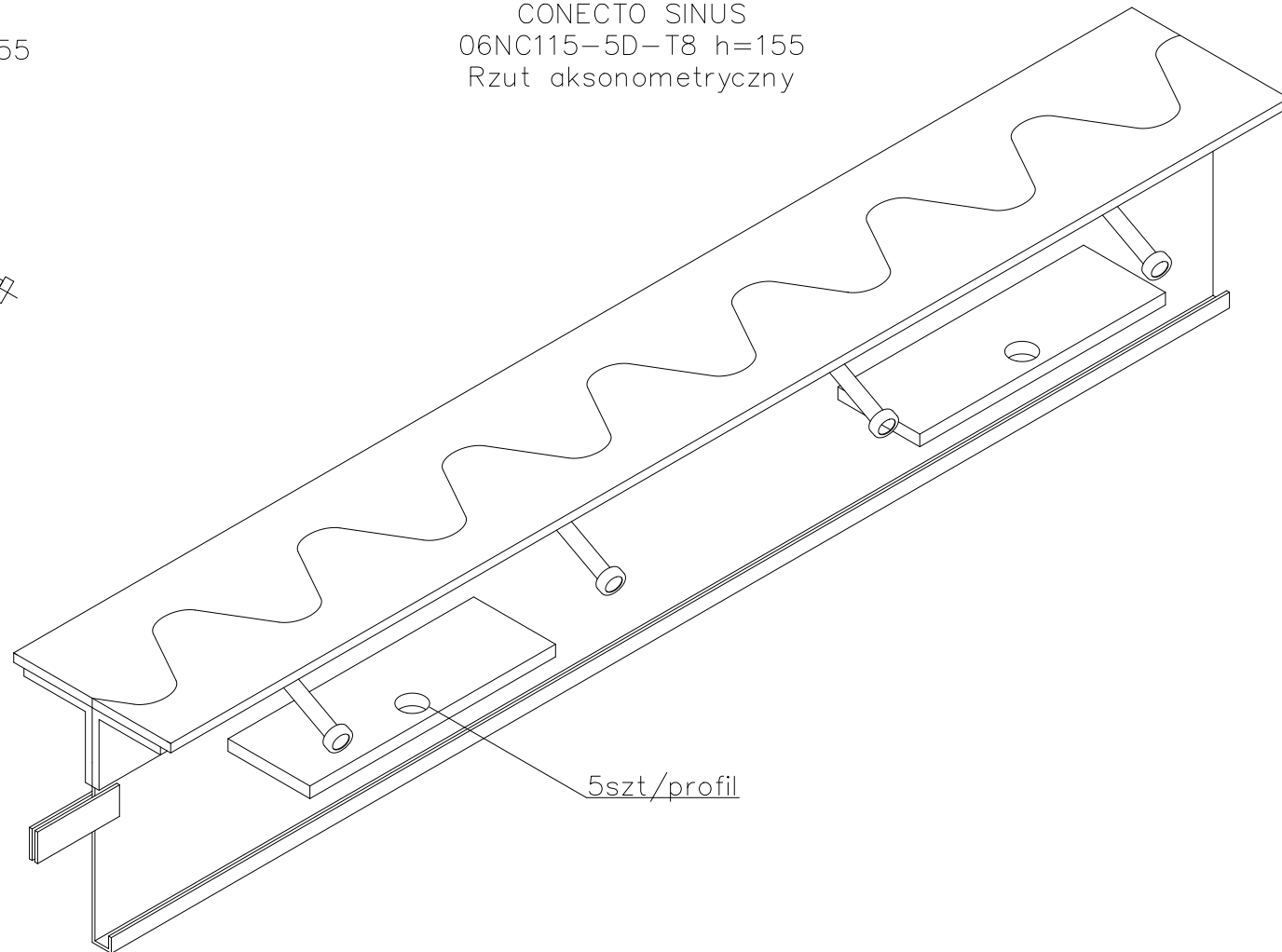

Profil dylatacyjny Conecto Sinus
06NC115-5D-T8 h=155
L=3000, Czarna stal

Conecto Profiles Sp. z o.o.
ul. Przemysłowa 39
61-541 Poznań
www.conecto-profiles.com



ROZMIAR / SIZE	SKALA / SCALE	Wszystkie wymiary podano w [mm] All dimensions in [mm]
A3	1:1	

PROJEKT	PROJECT	ZŁOŻENIE	SUB ASSEMBLY	RYSUNEK	DRAWING	ARKUSZ	SHEET	WER	REV
--		--		01		1	Z DF	1	