

CONECTO SINUS
06NC50/20x40-5D-T8 h=155
Przekrój

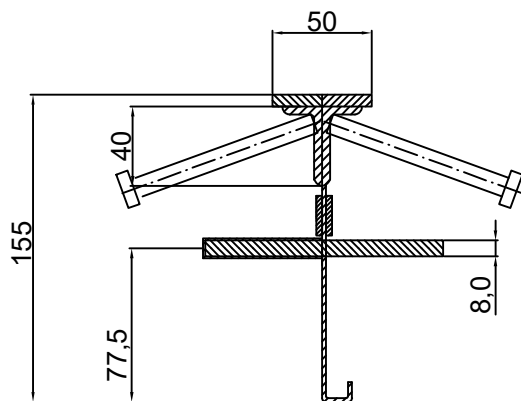

CONECTO SINUS
06NC50/20x40-5D-T8 h=155
Rzut aksonometryczny

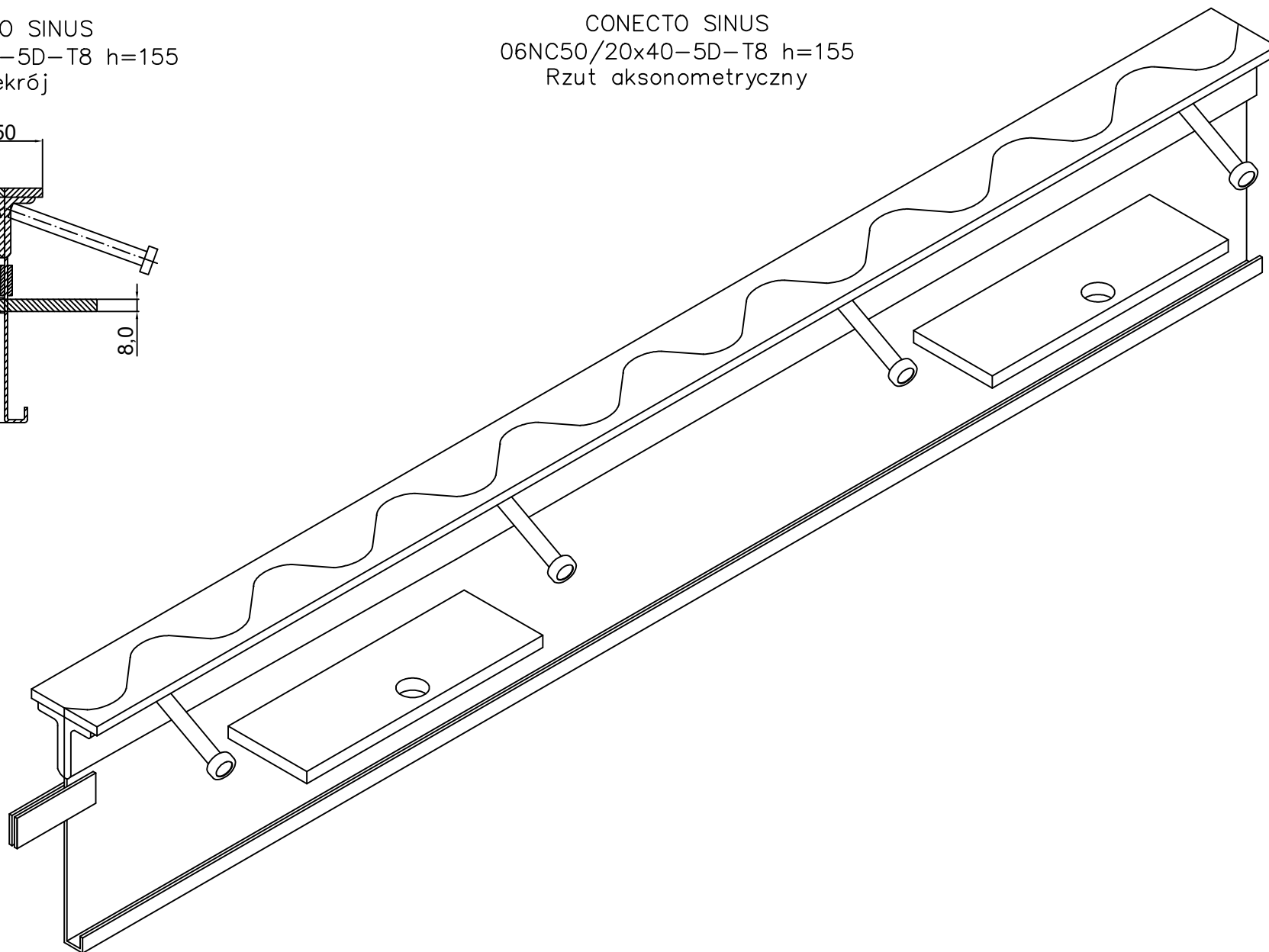

Profil dylatacyjny Conecto Sinus
06NC50/20x40-5D-T8 h=155
L=3000, stal czarna

Conecto Profiles Sp. z o.o.
ul. Przemysłowa 39
61-541 Poznań
www.conecto-profiles.com



ROZMIAR / SIZE	SKALA / SCALE	Wszystkie wymiary podano w [mm] All dimensions in [mm]		PROJEKT / PROJECT	ZŁOŻENIE / SUB ASSEMBLY	RYSUNEK / DRAWING	ARKUSZ / SHEET	VER / REV
A3	1:1			--	--	01	1 Z OF 1	